

**COMPOCEL<sup>®</sup> AL**



**COMPOCEL® AL**

A panel entirely in aluminum. It offers high mechanical properties, perfect when high rigidity and a low weight are required. Being a panel made of 95% aluminum, the fire reaction properties meet the reference standards for numerous applications.

**COMPOCEL® AL FR**

Certified version, compliant with the most stringent regulations in the railway, naval and construction sectors.

**COMPOCEL® AL FR A2**

Panel for ceilings and ventilated facades, class A2, therefore non-combustible. Thanks to special assembly techniques, COMPOCEL AL® FR A2 meets the requirements of the UNI-EN 13501-1 standard

In order to offer the correct panel, it is necessary to specify at the beginning any certification and conformities required.

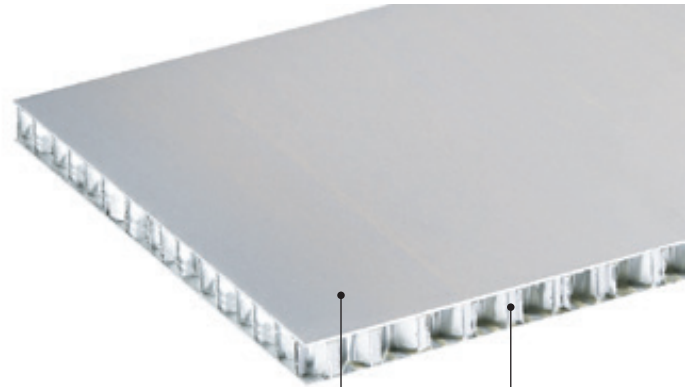

**ALUMINUM SKINS**  
Thickness mm: 0,5 - 0,8 - 1 (standard)

**CORE**  
Aluminum honeycomb (Alloy SerieS 3000 \*), hexagonal cells  
Diameter: Ø1/4", Ø3/8" Ø1/2", Ø3/4"  
Foil Thickness: from 50 to 70 microns

**TECHNICAL FEATURES**

TECHNICAL CHARACTERISTICS	panel size	mm	standard 1250 x 2500 / 1250 x 3000 / 1500 x 3000; On request up to 2000 x 7000								
	thickness' tolerance	mm	± 0,3								
	dimension's tolerance	mm	± 30								
	planarity ***	mm/m	+/-1								
	skins' thickness	mm	from 0,5 to 5,0								
	skin alluminium alloy		1000 series, 3000 series, 5000 series								
	honeycomb alluminium alloy		3000 series, 5000 series								
	thickness of honeycomb foil	µm	50 and 70								
	diameter of honeycomb	Ø = mm	from 3 to 19								
	honeycomb density	Kg/m³	from 20 to 163								
	adhesive		two-components polyurethane adhesive/thermoplastic film/ epoxy film/ two-components epoxy adhesive								
skin characteristics		rough/primer/polyester/PVDF/ anodised									
PANEL PHYSIC AND MECHANIC PERFORMANCES	type panel (some examples)	Panel Thickness mm	6	10	15	10	15	20	25		
		Skin Thickness mm	0,5 + 0,5			1,0 + 1,0					
	panel weight ‡	Kg/m²	3,8	4,0	4,3	6,7	7,0	7,3	7,6		
	compressive stabilised strength MPa ** ‡	ASTM C 365-365 M	Mpa	2,9							
	maximum load ** ‡	ASTM C 393 †	N	190	340	520	600	1.000	1.350	1.700	
	deflection at maximum load ‡	ASTM C 393 †	mm	14	8	6	8	6	4	3	
	skins E Elastic Modulus		Mpa	68.000 - 70.000							
	moment of inertia I **		mm⁴/m	7.600	22.000	52.000	40.000	98.000	181.000	288.000	
	average resistance to peeling ** ‡	ASTM D1781-98 (2012)		> 280 N/76 mm or 40 Nmm/mm							
	maximum service temperature **		°C	- 40 / + 60; on request + 80 / + 100 / + 150							
	thermal expansion coefficient **		°C-1	2,3 x 10 <sup>-5</sup>							

\*\* Tested by Internal Laboratory

\*\*\* Approximate value

† Sample dimension with 4 support points (L, W) 540x50mm; distance among the lower points 500mm, distance among the upper points 250mm

‡ Values for a panel with a honeycomb core of Ø6 56kg/m3 (Ø 1/4")

# OUR RANGE

Standard dimensions

customized sizes by request - Tolerance  $\pm 30$ mm

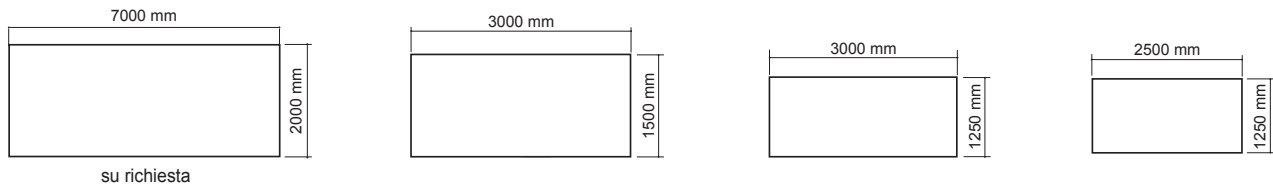

Honeycomb core's properties	50 Microns				70 Microns			
Type	ALUMINIUM ALLOY 3003/3005/3103/3104				ALUMINIUM ALLOY 3003/3005/3103/3104			
Ø honeycomb in mm	6	9	12	19	6	9	12	19
Ø honeycomb in inches	1/4"	3/8"	1/2"	3/4"	1/4"	3/8"	1/2"	3/4"
Density Kg/m <sup>3</sup>	56 - 59	39 - 40	29 - 30	20 - 21	80 - 83	54	40 - 42	27 - 29
Compressive stabilised strength MPa	3,0 - 3,5	1,4 - 1,95	0,8 - 0,95	0,4 - 0,6	4,3 - 4,6	2,5 - 2,6	1,41 - 1,5	0,85 - 0,9

## PROCESSING

\* On request available processing for certified panels

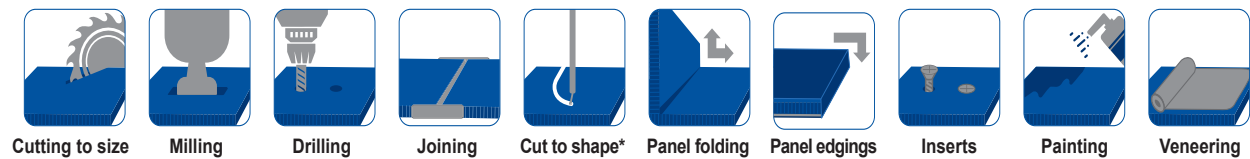

### CUTTING, SAWING, DRILLING AND SHAPING\*

These mechanical processes are performed by a CNC programmed by a specialized staff. CEL is able to produce customized shapes, holes and processings, according to the customer specifications.

### JOINING AND FIXING

Some projects require an anchoring systems to fasten panels to other surfaces.

Cel offers different options:

- panels attached to each other by visible or blind **rivets** and screws;
- fixing with **self-tapping screws** (sealing washers) in aluminium or stainless steel
- fastening with **drilling screws**.

### SUPERFICIAL FINISHING

#### Oxidation

Aluminium sheets can be covered with an anodic oxidation coating. This process increases corrosion and wear resistance, improving adhesion for paint, primers and glues.

#### Paintings

Aluminium panels can be finished with powder or liquid paints, combining aesthetics with environmental needs; Antibacterial and dissipating paints for indoor and outdoor are available on request.

#### Serigraphy

High resolution and durable printing are possible thanks to the use of UV resistant inks.

### EDGING

Compecel AL panels can be finished with various types of edging, depending on the aesthetic and mechanical requirements:

#### Flat edging (or applied edge)

For this type of edging, extrusions made of different materials can be used: aluminum, laminate, PVC, ABS, of different colours.

#### T-profile Edge

After milling the panel core, a T extrusion is applied to the edge with suitable glues. The combination between profile and glue gives greater strength and rigidity.

#### C - Edge profile

Extrusions are glued after milling part of the honeycomb or foam. The result is an excellent aesthetic quality and greater durability in the outer edge.















#### Folding the upper skin over the panel edge\*



The core is partially removed by milling along the edge to be folded. The skin is then folded and glued over the edge. The result is an aesthetically homogeneous and perfectly processed panel.

### FOLDING FOR TRAY PRODUCTION

One skin and the core are cut to get V-shaped or rectangular grooves along fold lines, without cutting the upper skin, adhesive is applied and the panel bent in order to get the final shape.

## COMPOCEL AL - REACTION TO FIRE

SECTOR	NORM	CLASSIFICATION	DESCRIPTION	CERTIFIER
	 MED IMO 0407	<b>MOD. B</b> <b>Low flamespread</b>	Aluminum honeycomb panel complying with the MED directive for the application in ships registered or applied in the European Union. Item N. MED / 3.18a, IMO 2010 FTP Code, Annex 1	Istituto Giordano
		<b>MOD. D</b> <b>Low flamespread</b>		
	<b>PARATIA C. CLASS DIVISION</b> <b>Incombustibility</b>	Aluminium honeycomb panel complying with the MED Item N. MED / 3.64, FTP Code IMO 2010, Annex 1		
	 U.S Coast Guard	<b>MOD B</b> <b>MOD D</b>	Aluminium honeycomb sandwich panel	Istituto Giordano
	 UNI EN 13501-1	<b>A2 s1 d0</b> <b>Incombustibility</b>	A2 - Non combustible s1 - Smoke emission absent d0 - no dripping	Leitat
		COMPOCEL AL FR COMPOCEL AL FLOOR, ALURIS, ALUMAN		Istituto Giordano
	 UNI EN 13501-1	<b>A2fl s1 d0</b> <b>Incombustibility</b>	A2fl - Non combustible s1 - Smoke emission absent d0 - no dripping	Istituto Giordano
		COMPOCEL AL FR COMPOCEL AL FLOOR, ALURIS, ALUMAN		
	 UNI EN 13501-1	<b>Bfl s1 d0</b> <b>Low flamespread</b>	Bfl - LOW FLAME SPREAD s1 - Smoke emission absent d0 - no dripping	Istituto Giordano
	 UNI EN 13501-1	<b>A2 s1 d0</b> <b>Incombustibility</b>	<i>Only 20mm</i> A2 - Non combustible s1 - Smoke emission absent d0 - no dripping	Istituto Giordano
	 NFP 92-507	<b>M1</b> <b>Not flammable</b>	M1 - Not flammable	C.S.T.B.
		 UNI EN 13501-1	<b>B s1 d0</b> <b>Low flamespread</b>	B - LOW FLAME SPREAD s1 - Smoke emission absent d0 - no dripping
	 UNI EN 45545	<b>HL3</b> <b>Hazard level</b>	Meets requirements for applications: R2 - Suspended ceilings, countertop R1 - Partitions R10 - Floors	Istituto Giordano

AMERICAN STANDARDS							CERTIFIER
		ASTM C67-M18 Water absorption	ASTM E72-15 Transversal load resistance	ASTM C297 M-16 Resistance to traction	ASTM E84-17 Flame propagation	TAS 201, 203 Hurricane resistance	Intertek





(1)

## STIFFNESS-TO-WEIGHT RATIO

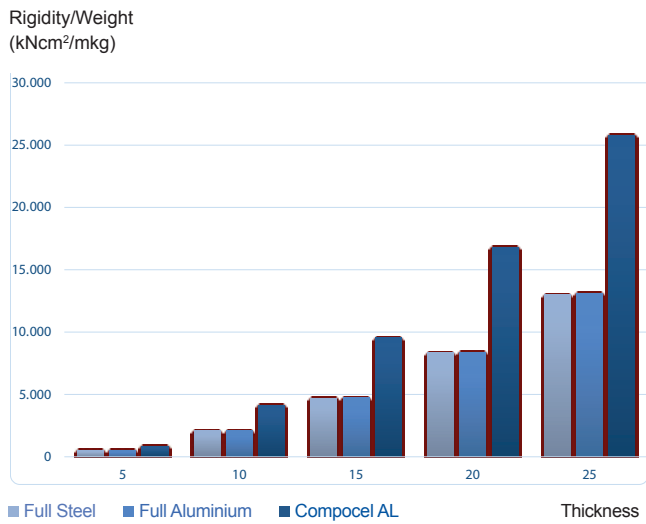

(2)

## PICTURES

The images show direct experiences of the company in the various sectors illustrated.

- (1) Terminal 2E facade, sat. A, Charles de Gaulle;
- (2) Station shelters and train interiors;
- (3) Countertops and doors;
- (4) Furniture and walls for the medical sector;
- (5) Paneling for cabins and elevators;
- (6) Lightweight panels for shipyards.



(3)



## EXAMPLES OF HOOKING

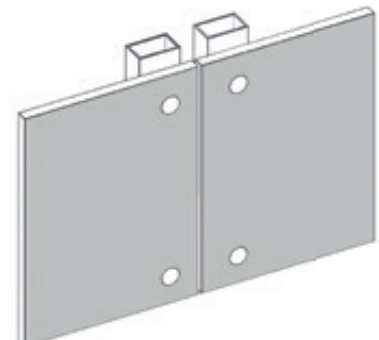
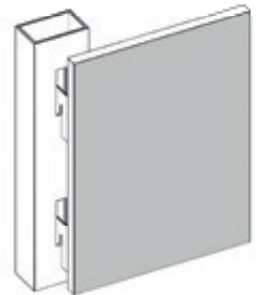
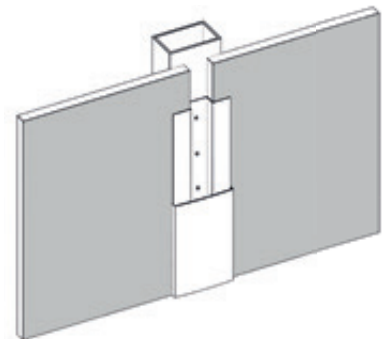



# USEFUL INFORMATIONS

STANDARD COLORS

ON REQUEST

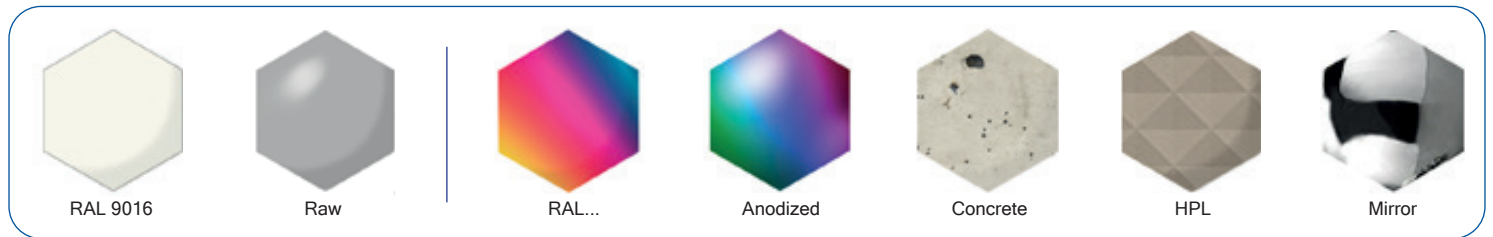

## ABOUT US

CEL panels are produced in Italy, in Villanova di Castenaso, nearby Bologna.

The choice of materials takes place after a careful selection and evaluation of suppliers, supply capacities and product quality.

Customer satisfaction is the main goal. For this reason CEL is committed to supply only materials of the highest quality, result of refined processes and stringent selections.

## PROCESSING/USE/STORAGE/MAINTENANCE

COMPOCEL AL can be processed with various types of machinery: from carpentry saws to the most advanced CNCs. CEL offers perforation, edging and riveting operations.

The User Manual indicates the conditions in which the material must be stored and preserved. Storage temperature, handling, exposure to light and atmospheric agents are just some of the factors that affect the panel conservation and its qualities.

Particular attention must be paid to protective films that could be of difficult removal when the panel has been subjected to atmospheric agents or a prolonged storage period of time.

The panel can be easily cleaned and degreased, however the use of acidic substances or abrasive components is not recommended as they could compromise its aesthetic qualities.

## FINISHING

COMPOCEL AL finishes are selected carefully for indoor and outdoor applications; high quality polymeric paint such as PVDF and FEVE are available on request.

CEL offers various surface treatments, in order to resist to heat peaks and temperatures.

Overall orders are necessary in case customer needs specific finishes or colours; in this way all aluminium sheets are produced in a batch without any minimal pigment variation.

## RESEARCH

CEL combines quality and innovative solutions in order to meet the individual needs of each customer.

The company has two laboratories to carry out chemical and mechanical tests.

Other tests, such as fire reaction tests, are issued by external laboratories.

In strict collaboration with its customers, CEL develops new Products and design, and testing both new materials and non-standard finishes.

## SUSTAINABILITY AND ENVIRONMENT

CEL commitment for Environmental protection and product sustainability is the backbone for new processing decisions.

The factory plant has been designed to limit both air and acoustic emissions, while the produced heat is reused in indoor spaces, thus limiting the use of other heating sources.

The choice of Local suppliers does not only limit the impact of hydrocarbons on the environment, but it also supports local economy, and shortens delivery times.

In addition, discarded materials are used either to carry out tests or to realize small samples.

Cel uses mainly recycled material, wood and cardboard for packaging.

## SAFETY AND HEALTH

Workers' health and safety are a primary corporate goal. CEL insists on the correct installation of protective barriers and PPE. Safety standards have become part of CEL operating procedures. CEL produces in compliance with the ISO 9001-2015 standard and is working to get ISO 45001.

## RECYCLING

COMPOCELAL panel is 95% recyclable as it is composed of 95% aluminium, which can be melted and reused multiple times.

If the panel is covered with other materials, it is necessary to verify with the competent supply chains about the disposal and recycling options.

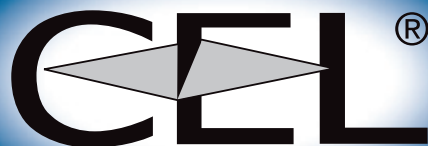

## SANDWICH PANELS AND HONEYCOMB

**CEL Components S.r.l.**

Via Ca' dell'Orbo Sud, 4 · 40055 Castenaso (Bo) Italy

Tel. +39 051 782505 · Fax +39 051 782477

info@cel.eu

**www.cel.eu**    



WEB SITE

LIABILITY DISCLAIMER: The above data are to the best of our knowledge correct and are intended to give information about our products and their potential applications. No warranty is given or implied in respect of certain properties of the products or their suitability for a particular application. We reserve the right for technical changes without further notice. We guarantee impeccable product quality under our terms of sale.



UNI EN ISO  
9001:2015  
Reg No: 9910-A